

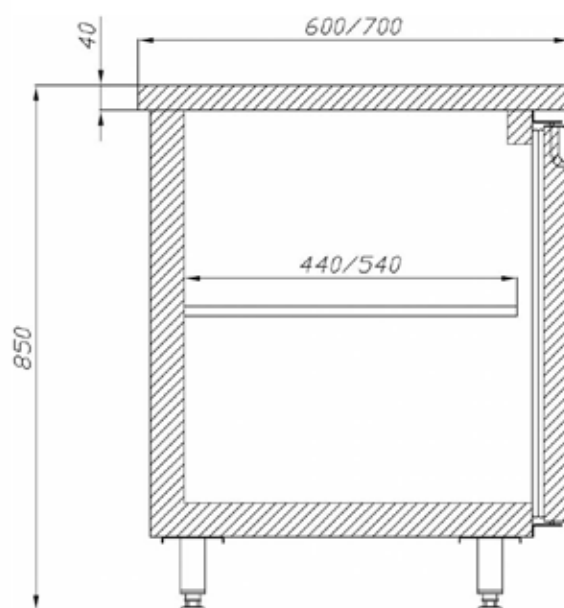









## Freezing Working Tables - J-JK-74



J-JK-74\*



### Technical parameters:

Models	Dimension (ext.) H x W x D [mm]	Doors	Shelves	Drawers	Capacity [dm <sup>3</sup> ]	Power Consumption [kWh/24h]	Weight [kg]	Doors Drawers options
J-JK-74 1.3	850 x 1300 x 700	2	2	0	300	4,20	110	
J-JK-74 1.3 2DRW	850 x 1300 x 700	1	1	2	300	4,20	110	
J-JK-74 1.3 4DRW	850 x 1300 x 700	0	0	4	300	4,20	110	
J-JK-74 1.4	850 x 1400 x 700	2	2	0	350	4,30	120	
J-JK-74 1.4 2DRW	850 x 1400 x 700	1	1	2	350	4,30	120	
J-JK-74 1.4 4DRW	850 x 1400 x 700	0	0	4	350	4,30	120	
J-JK-74 1.5	850 x 1500 x 700	2	2	0	400	4,40	130	
J-JK-74 1.5 2DRW	850 x 1500 x 700	1	1	2	400	4,40	130	
J-JK-74 1.5 4DRW	850 x 1500 x 700	0	0	4	400	4,40	130	

\* - Picture above presents unit with either some or all available extras. Please note that the look of basic version of cabinet, or one of your choice, may vary from presented.

## Freezing Working Tables - J-JK-74



J-JK-74\*

### Description:

- temperature range -18 / -22°C
- preferred ambient temperature +16 / +25°C
- power supply 230V / 50Hz
- internal condensing unit placed on the bottom
- interior and body made of stainless steel
- stainless steel worktop (40mm thick)
- electronic control with temperature display
- automatic defrost and evaporation system
- forced air circulation
- 1 year full warranty service and after warranty service provided

### Available options:

- granite worktop 30mm thick - optional colours
- additional shelf with guide

### Optional colours:



\* - Picture above presents unit with either some or all available extras. Please note that the look of basic version of cabinet, or one of your choice, may vary from presented.